

N-channel 100 V, 2.6 mΩ typ., 180 A, STripFET™ F7 Power MOSFET in a TO-247 package

Datasheet - production data

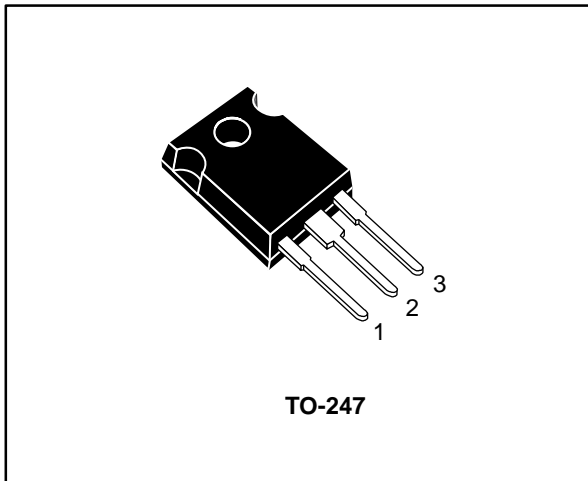
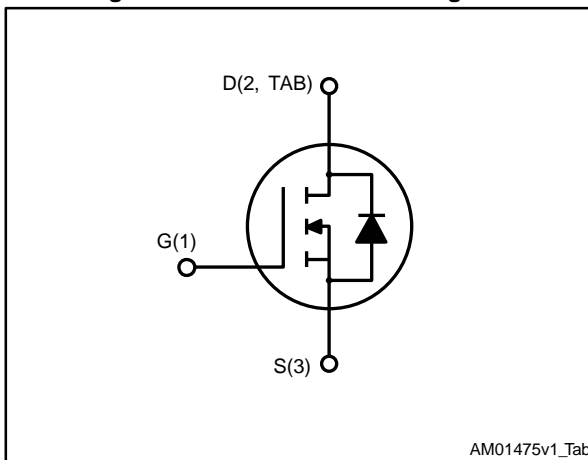

Figure 1: Internal schematic diagram



Features

Order code	V _{DS}	R _{DS(on)} max.	I _D
STW240N10F7	100 V	3.0 mΩ	180 A

- Among the lowest R_{DS(on)} on the market
- Excellent FoM (figure of merit)
- Low C_{rss}/C_{iss} ratio for EMI immunity
- High avalanche ruggedness

Applications

- Switching applications

Description

This N-channel Power MOSFET utilizes STripFET™ F7 technology with an enhanced trench gate structure that results in very low on-state resistance, while also reducing internal capacitance and gate charge for faster and more efficient switching.

Table 1: Device summary

Order code	Marking	Package	Packing
STW240N10F7	240N10F7	TO-247	Tube

Contents

1	Electrical ratings	3
2	Electrical characteristics	4
	2.1 Electrical characteristics (curves).....	6
3	Test circuits	8
4	Package information	9
	4.1 TO-247 package information.....	9
5	Revision history	11

1 Electrical ratings

Table 2: Absolute maximum ratings

Symbol	Parameter	Value	Unit
V_{DS}	Drain-source voltage	100	V
V_{GS}	Gate-source voltage	± 20	V
$I_D^{(1)}$	Drain current (continuous) at $T_C = 25\text{ }^\circ\text{C}$	180	A
	Drain current (continuous) at $T_C = 100\text{ }^\circ\text{C}$	160	A
$I_D^{(2)}$	Drain current (pulsed)	720	A
P_{TOT}	Total dissipation at $T_C = 25\text{ }^\circ\text{C}$	300	W
$E_{AS}^{(3)}$	Single pulse avalanche energy	500	mJ
T_J	Operating junction temperature range	-55 to 175	$^\circ\text{C}$
T_{stg}	Storage temperature range		$^\circ\text{C}$

Notes:

(1) Current limited by package

(2) Pulse width limited by safe operating area

(3) Starting $T_J = 25\text{ }^\circ\text{C}$, $I_D = 45\text{ A}$, $V_{DD} = 50\text{ V}$

Table 3: Thermal data

Symbol	Parameter	Value	Unit
$R_{thj-case}$	Thermal resistance junction-case	0.5	$^\circ\text{C/W}$
$R_{thj-amb}$	Thermal resistance junction-ambient	50	$^\circ\text{C/W}$

2 Electrical characteristics

(T_{CASE} = 25 °C unless otherwise specified)

Table 4: On/off-state

Symbol	Parameter	Test conditions	Min.	Typ.	Max.	Unit
V _{(BR)DSS}	Drain-source breakdown voltage	V _{GS} = 0, I _D = 250 μA	100			V
I _{DSS}	Zero gate voltage drain current	V _{GS} = 0, V _{DS} = 100 V			1	μA
		V _{GS} = 0, V _{DS} = 100 V; T _C = 125 °C ⁽¹⁾			100	μA
I _{GSS}	Gate body leakage current	V _{DS} = 0, V _{GS} = 20 V			100	nA
V _{GS(th)}	Gate threshold voltage	V _{DS} = V _{GS} , I _D = 250 μA	2.5		4.5	V
R _{DS(on)}	Static drain-source on- resistance	V _{GS} = 10 V, I _D = 90 A		2.6	3.0	mΩ

Notes:

⁽¹⁾Defined by design, not subject to production test.

Table 5: Dynamic

Symbol	Parameter	Test conditions	Min.	Typ.	Max.	Unit
C _{iSS}	Input capacitance	V _{GS} = 0, V _{DS} = 25 V, f = 1 MHz	-	11550	-	pF
C _{oSS}	Output capacitance			2950		pF
C _{rSS}	Reverse transfer capacitance			217		pF
Q _g	Total gate charge	V _{DD} = 50 V, I _D = 180 A	-	160	-	nC
Q _{gs}	Gate-source charge	V _{GS} = 10 V		48		nC
Q _{gd}	Gate-drain charge	(see Figure 14: "Test circuit for gate charge behavior")		38		nC

Table 6: Switching times

Symbol	Parameter	Test conditions	Min.	Typ.	Max.	Unit
t _{d(on)}	Turn-on delay time	V _{DD} = 50 V, I _D = 90 A, R _G = 4.7 Ω, V _{GS} = 10 V (see Figure 13: "Test circuit for resistive load switching times")	-	49	-	ns
t _r	Rise time			139		ns
t _{d(off)}	Turn-off delay time			110		ns
t _f	Fall time			112		ns

Table 7: Source-drain diode

Symbol	Parameter	Test conditions	Min.	Typ.	Max.	Unit
$V_{SD}^{(1)}$	Forward on voltage	$I_{SD} = 180 \text{ A}$, $V_{GS} = 0$			1.2	V
t_{rr}	Reverse recovery time	$I_{SD} = 180 \text{ A}$, $di/dt = 100 \text{ A}/\mu\text{s}$, $V_{DD} = 80 \text{ V}$, $T_j = 150 \text{ }^\circ\text{C}$ (see Figure 15: "Test circuit for inductive load switching and diode recovery times")		108		ns
Q_{rr}	Reverse recovery charge			315		nC
I_{RRM}	Reverse recovery current			5.8		A

Notes:

⁽¹⁾Pulsed: pulse duration = 300 μs , duty cycle 1.5%

2.1 Electrical characteristics (curves)

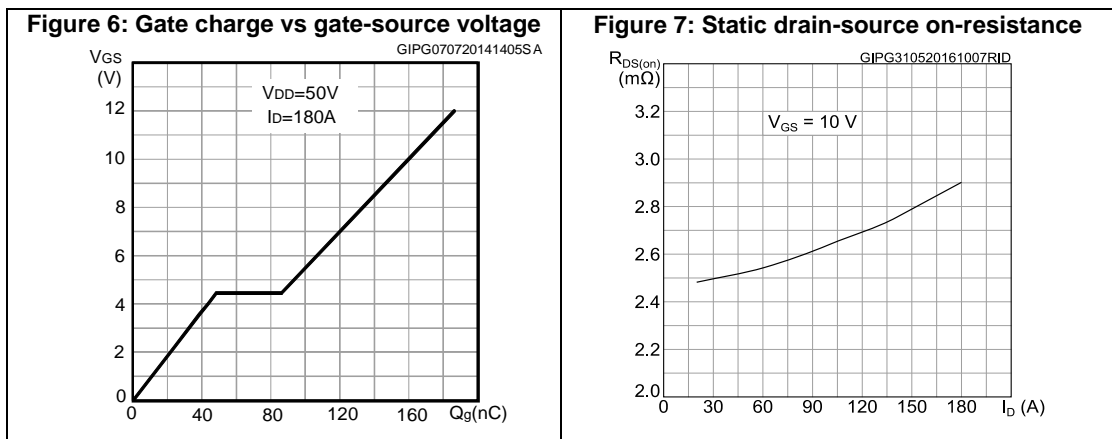
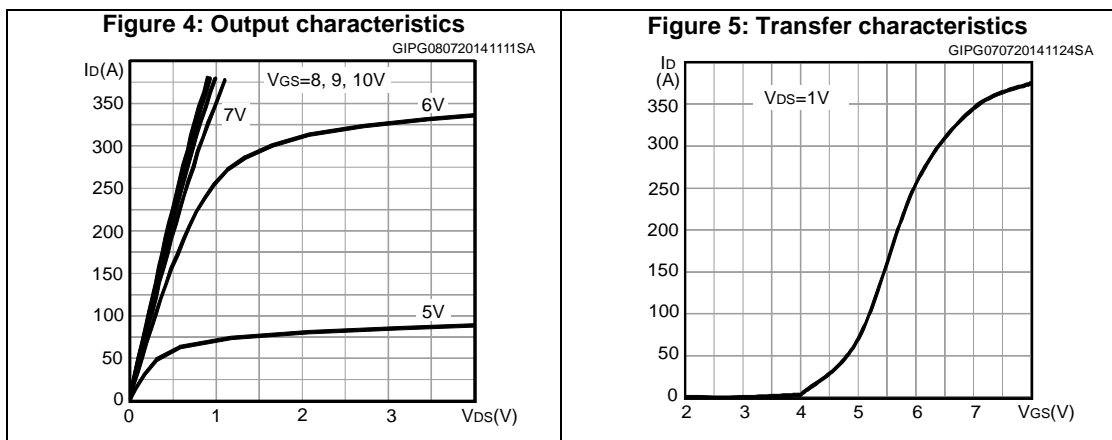
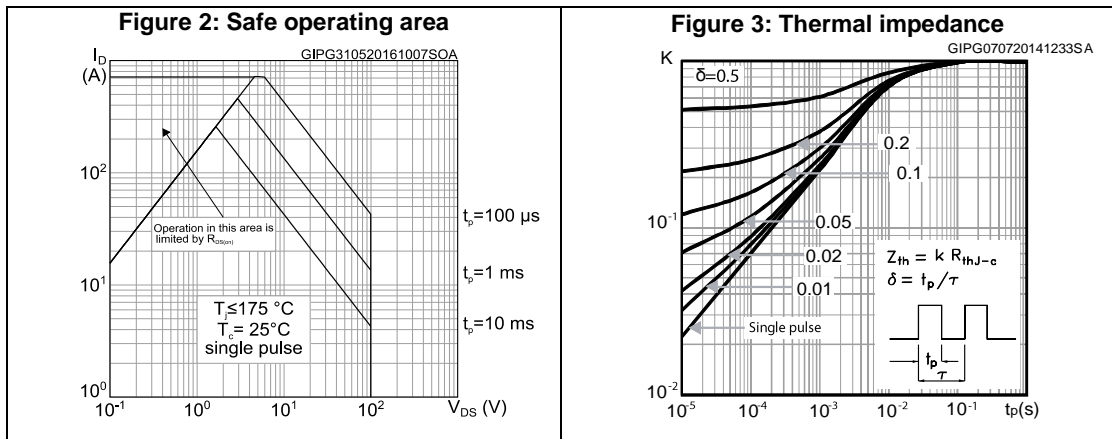

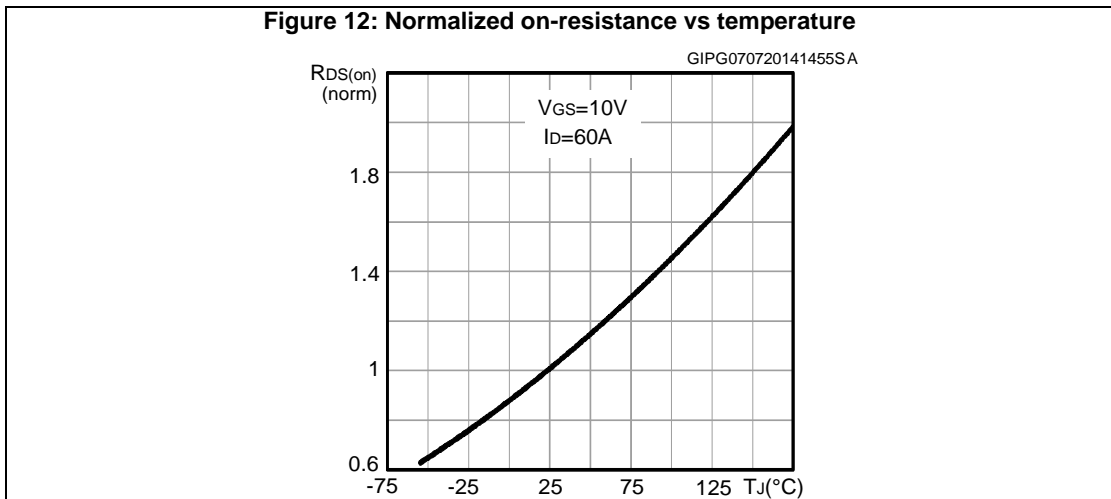
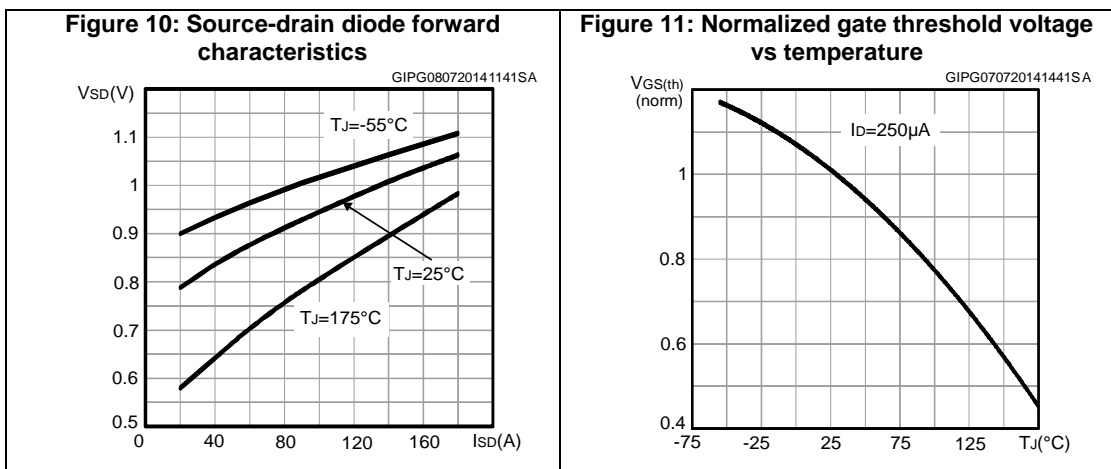
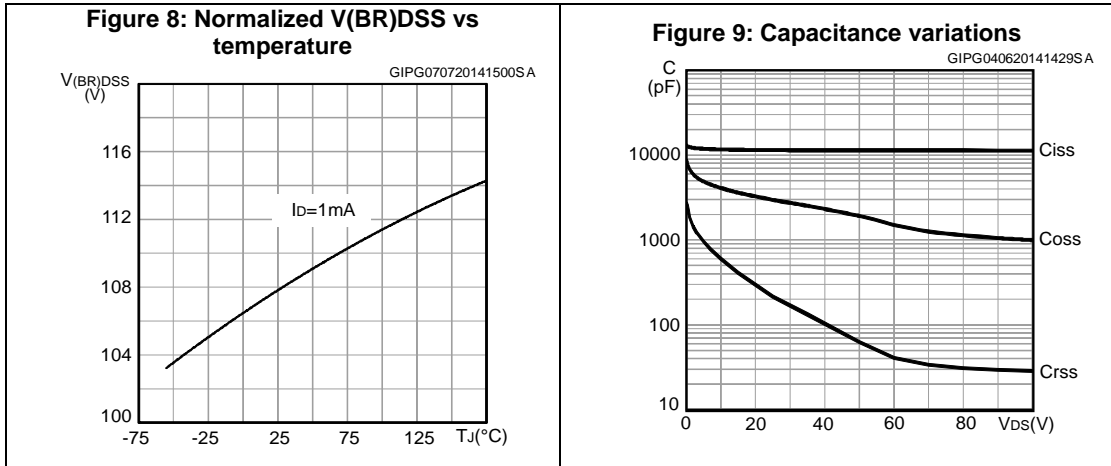

3 Test circuits

Figure 13: Test circuit for resistive load switching times

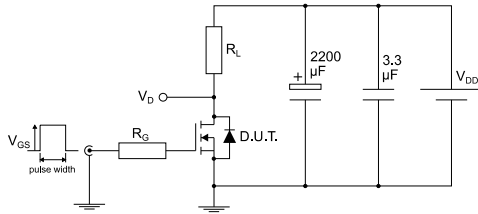

AM01468v1

Figure 14: Test circuit for gate charge behavior

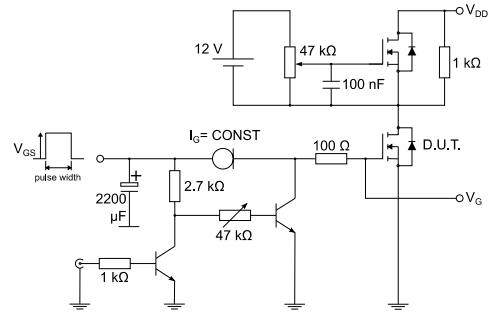

AM01469v1

Figure 15: Test circuit for inductive load switching and diode recovery times

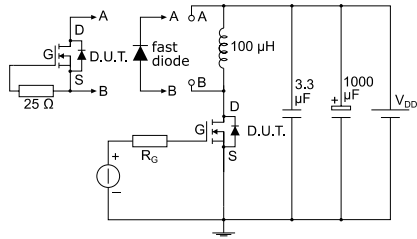

AM01470v1

Figure 16: Unclamped inductive load test circuit

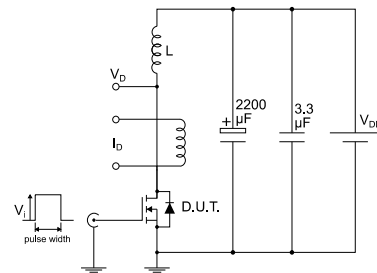

AM01471v1

Figure 17: Unclamped inductive waveform

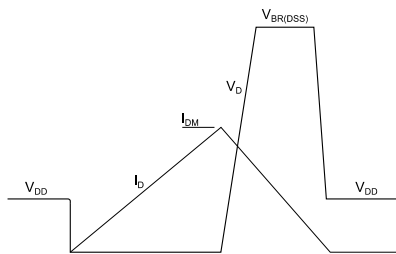

AM01472v1

Figure 18: Switching time waveform

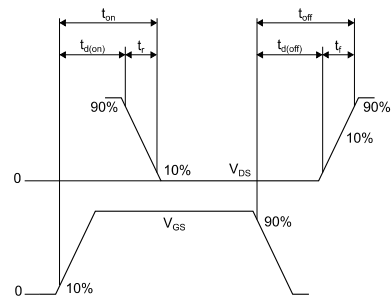

AM01473v1

4 Package information

In order to meet environmental requirements, ST offers these devices in different grades of ECOPACK® packages, depending on their level of environmental compliance. ECOPACK® specifications, grade definitions and product status are available at: www.st.com. ECOPACK® is an ST trademark.

4.1 TO-247 package information

Figure 19: TO-247 package outline

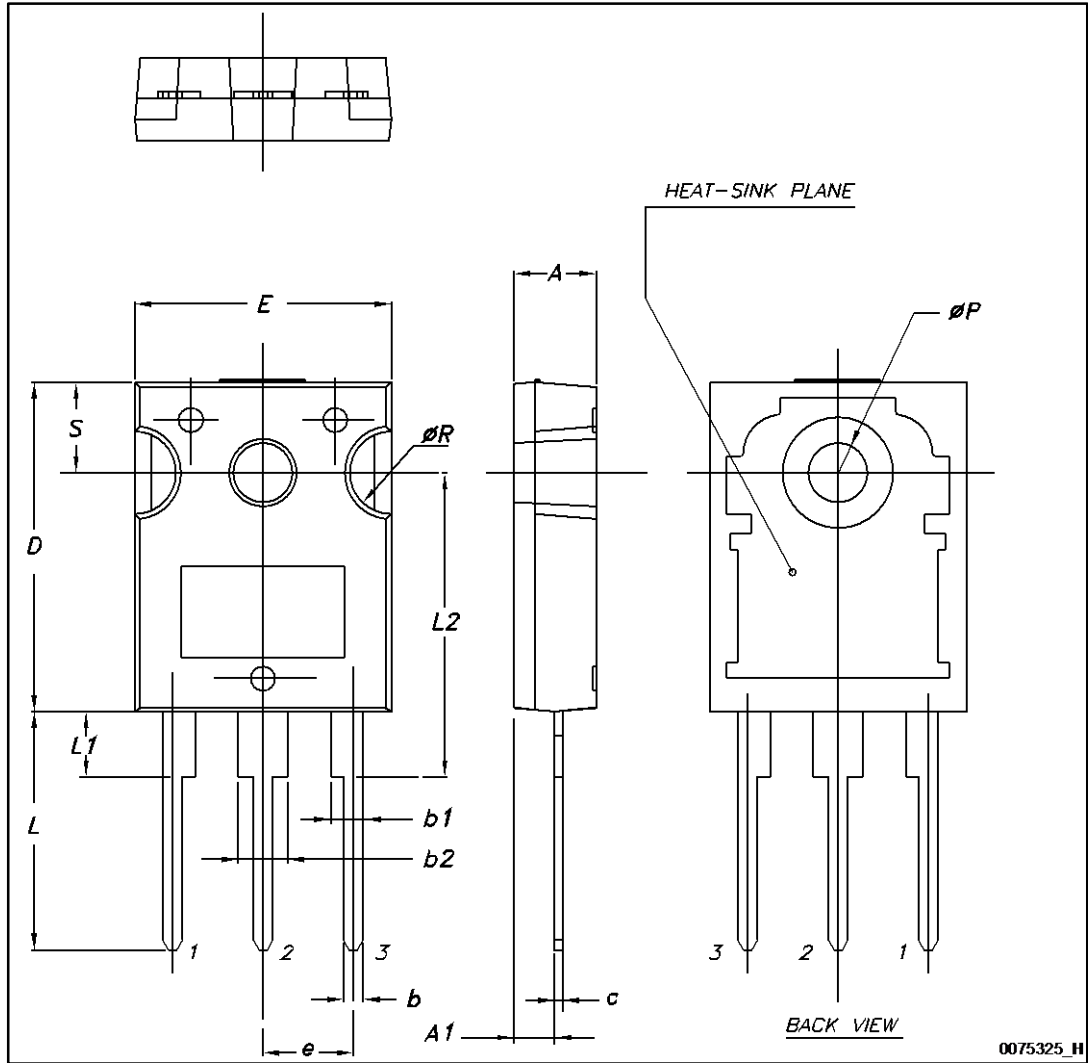

Table 8: TO-247 package mechanical data

Dim.	mm		
	Min.	Typ.	Max.
A	4.85		5.15
A1	2.20		2.60
b	1.0		1.40
b1	2.0		2.40
b2	3.0		3.40
c	0.40		0.80
D	19.85		20.15
E	15.45		15.75
e	5.30	5.45	5.60
L	14.20		14.80
L1	3.70		4.30
L2		18.50	
ØP	3.55		3.65
ØR	4.50		5.50
S	5.30	5.50	5.70

5 Revision history

Table 9: Document revision history

Date	Revision	Changes
06-Jun-2016	1	Initial release.
08-Jul-2016	2	Document status promoted from preliminary to production data.

IMPORTANT NOTICE – PLEASE READ CAREFULLY

STMicroelectronics NV and its subsidiaries ("ST") reserve the right to make changes, corrections, enhancements, modifications, and improvements to ST products and/or to this document at any time without notice. Purchasers should obtain the latest relevant information on ST products before placing orders. ST products are sold pursuant to ST's terms and conditions of sale in place at the time of order acknowledgement.

Purchasers are solely responsible for the choice, selection, and use of ST products and ST assumes no liability for application assistance or the design of Purchasers' products.

No license, express or implied, to any intellectual property right is granted by ST herein.

Resale of ST products with provisions different from the information set forth herein shall void any warranty granted by ST for such product.

ST and the ST logo are trademarks of ST. All other product or service names are the property of their respective owners.

Information in this document supersedes and replaces information previously supplied in any prior versions of this document.

© 2016 STMicroelectronics – All rights reserved

Mouser Electronics

Authorized Distributor

Click to View Pricing, Inventory, Delivery & Lifecycle Information:

[STMicroelectronics:](#)

[STW240N10F7](#)